

Endpoint characterization factors for freshwater eutrophication: testing different methods to obtain effect factors

Ligia B. Azevedo¹

Andrew D. Henderson^{2,3}

Rosalie van Zelm¹

Olivier Jolliet²

Mark A. J. Huijbregts¹

¹ Radboud University Nijmegen

² University of Michigan

³ The University of Texas, Houston

BACKGROUND

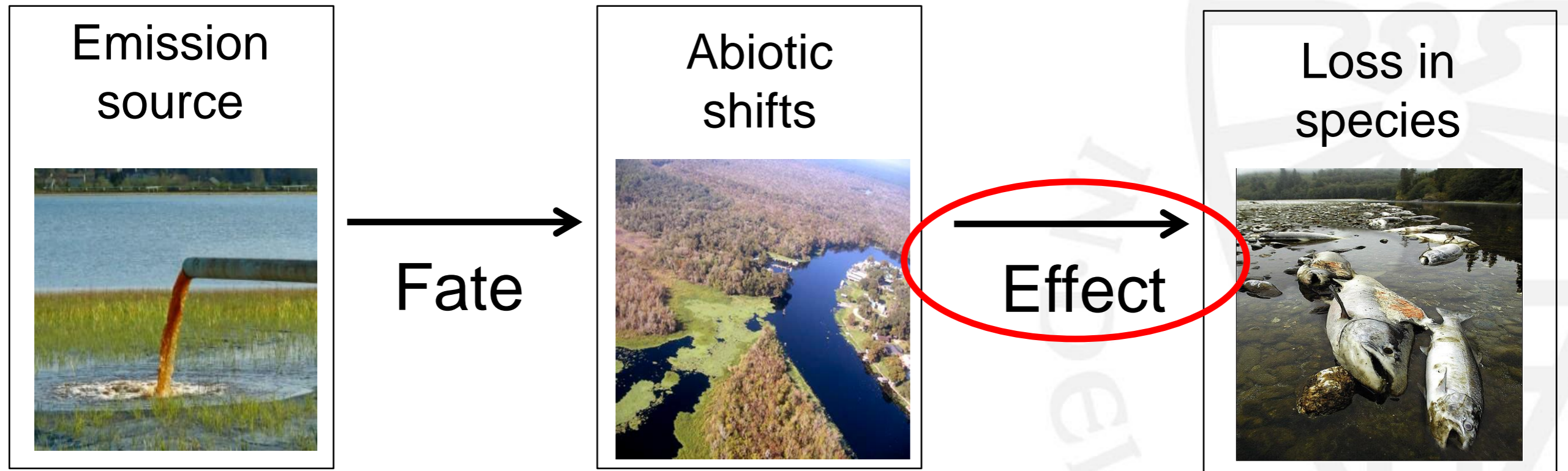

CONCLUSIONS

Endpoint characterization factors for freshwater eutrophication depend on the type of effect factor that is used

***Today's talk is on:
Depend on what, how much?***

APPROACH

Optimum

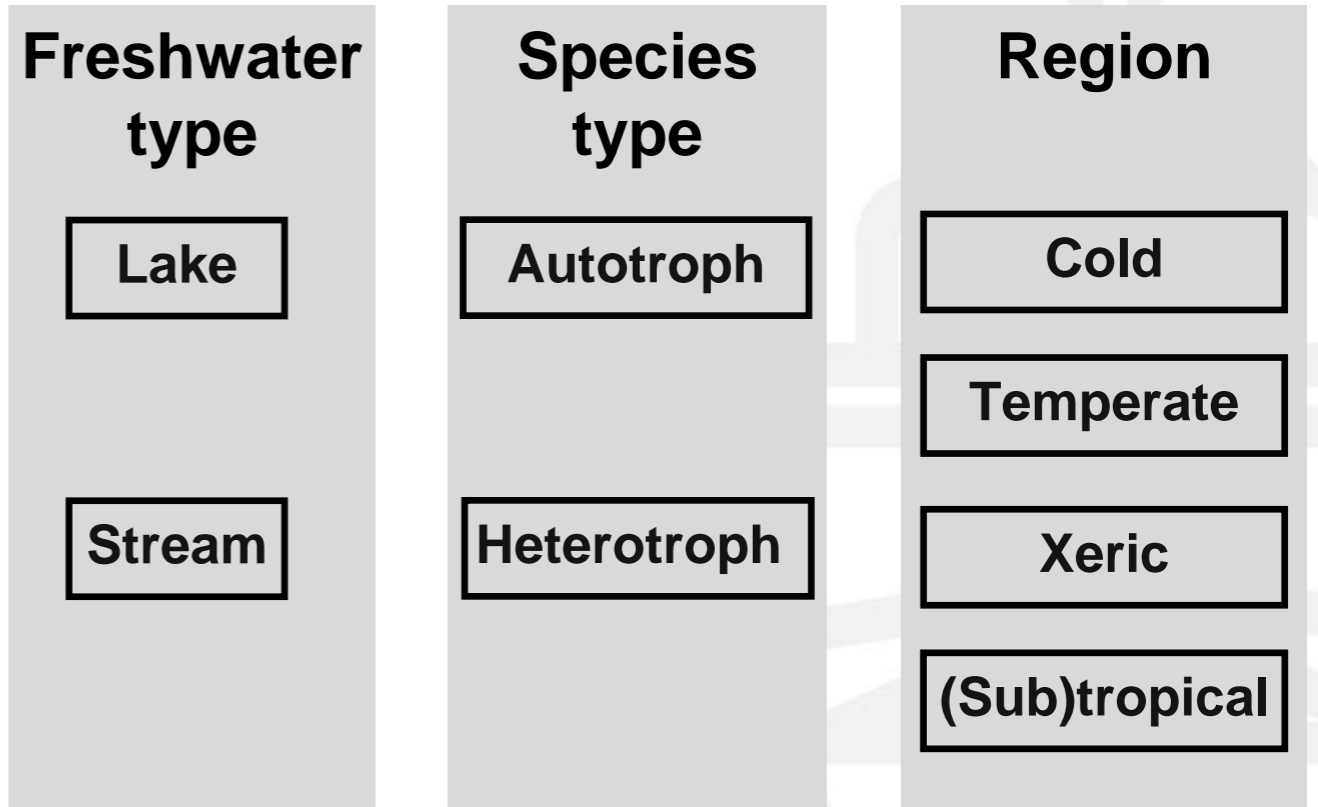
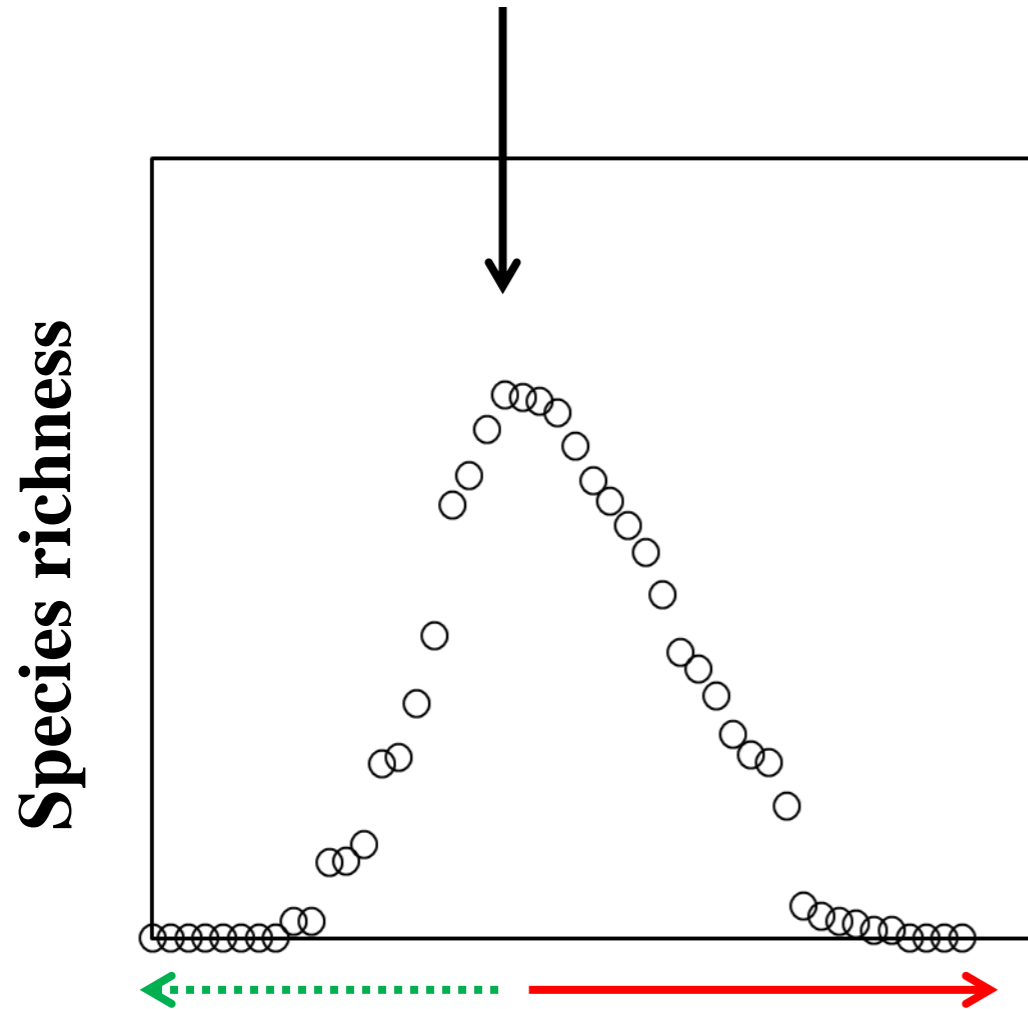

Occurrence/non-occurrence

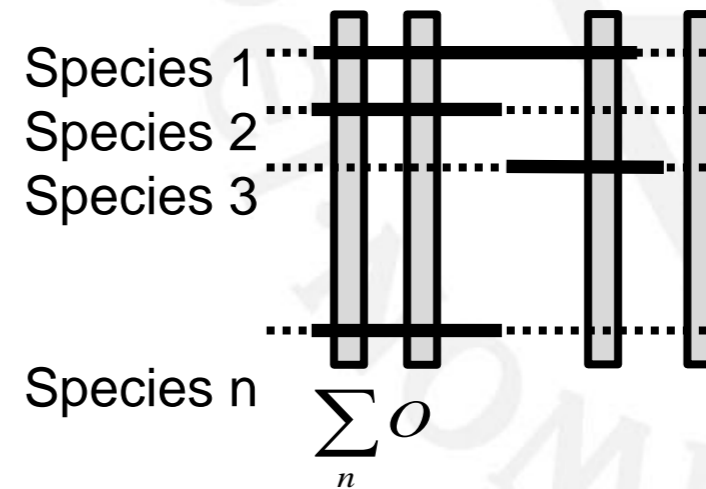

Computing Effect Factors

$$cPNOF = \frac{1}{1 + \exp\left[\frac{\log_{10}(TP) - \alpha}{\beta}\right]}$$

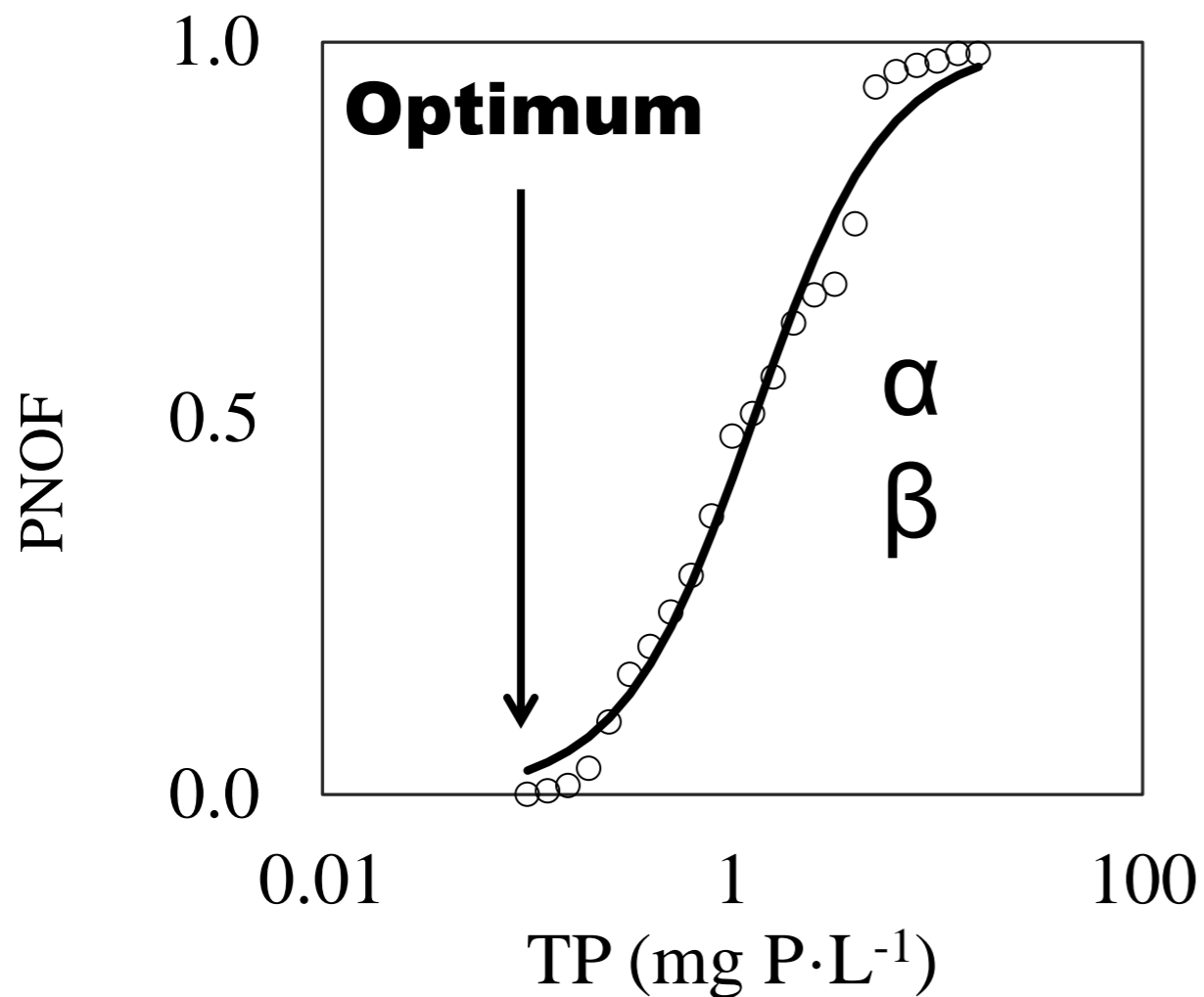

Computing Effect Factors

$$cPNOF = \frac{1}{1 + \exp\left[\frac{\log_{10}(TP) - \alpha}{\beta}\right]}$$

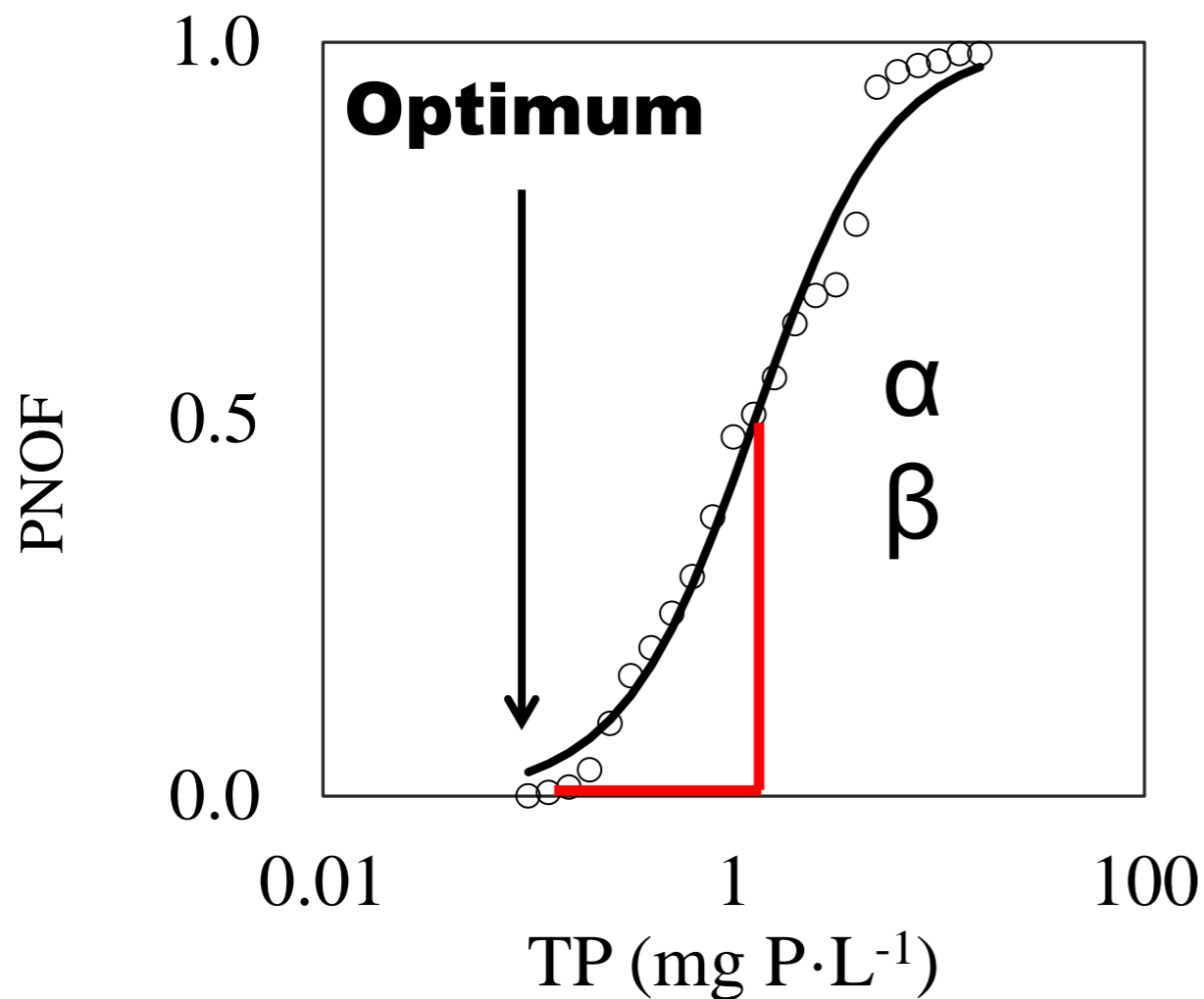

LEF (LINEAR):

$$LEF = \frac{0.5}{10^\alpha - Opt}$$

Computing Effect Factors

$$cPNOF = \frac{1}{1 + \exp\left[\frac{\log_{10}(TP) - \alpha}{\beta}\right]}$$

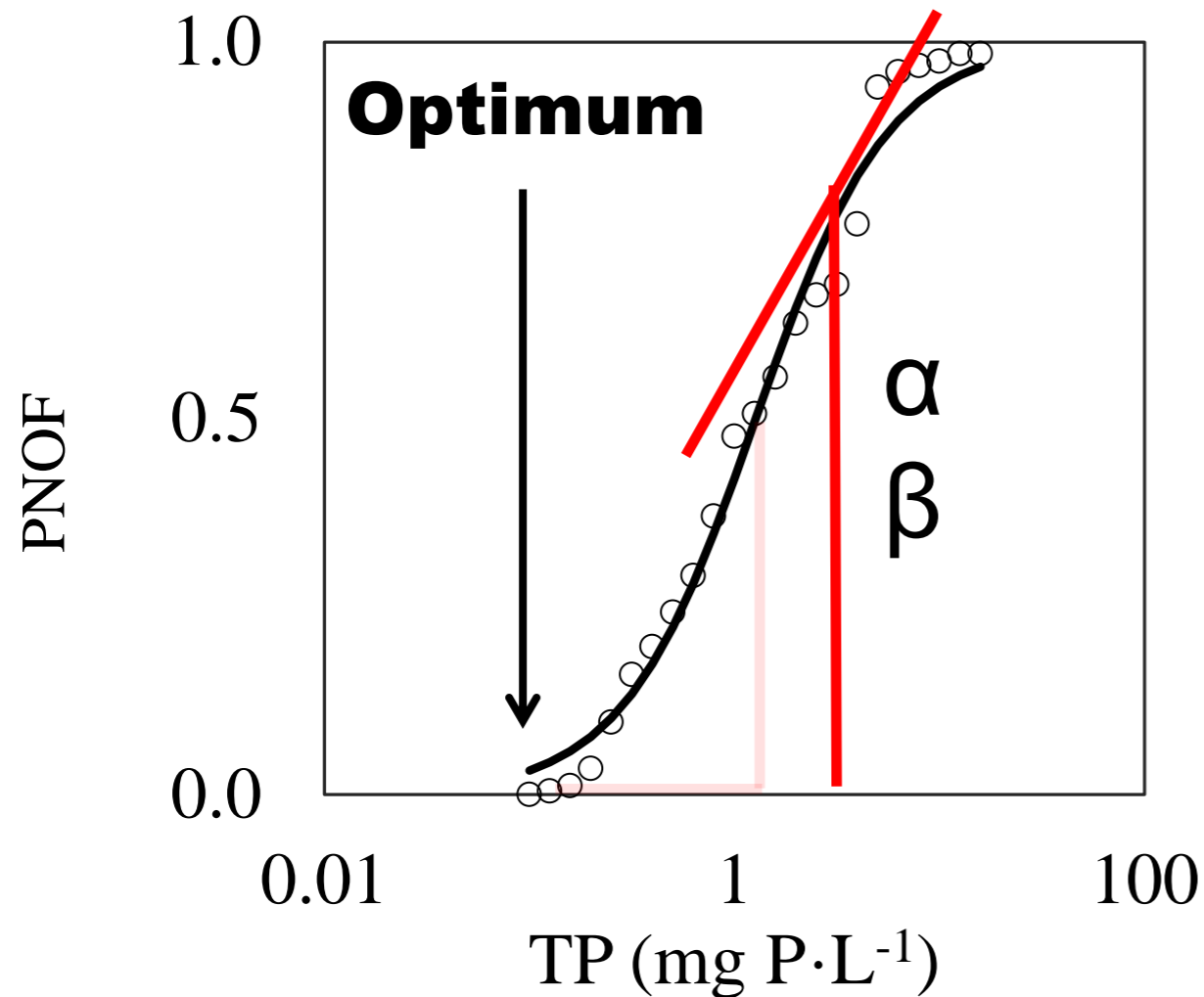

LEF (LINEAR):

$$LEF = \frac{0.5}{10^\alpha - Opt}$$

MEF (MARGINAL):

$$MEF = \frac{\partial PNOF}{\partial TP}, TP > Opt$$

Computing Effect Factors

$$cPNOF = \frac{1}{1 + \exp\left[\frac{\log_{10}(TP) - \alpha}{\beta}\right]}$$

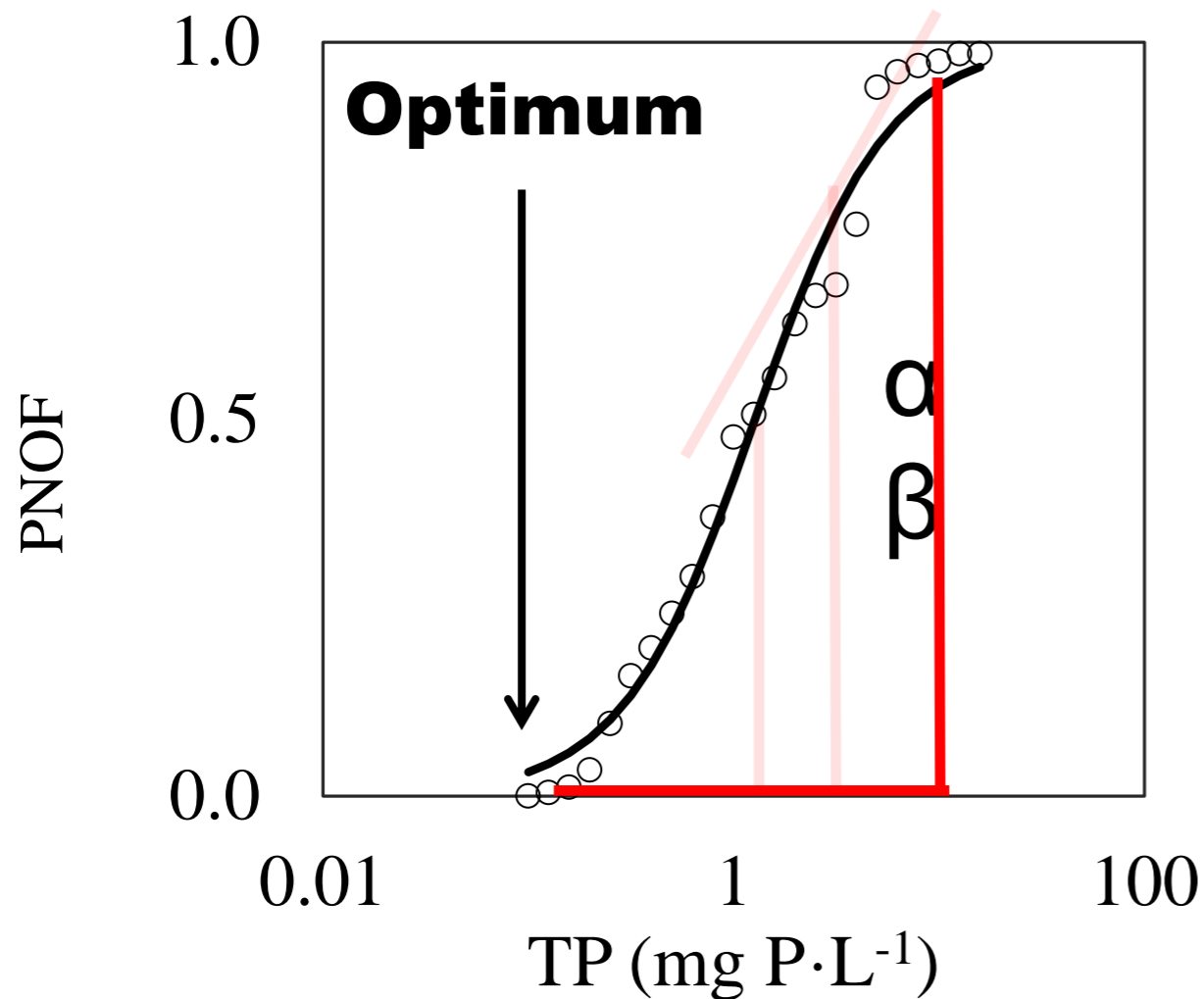

LEF (LINEAR):

$$LEF = \frac{0.5}{10^\alpha - Opt}$$

MEF (MARGINAL):

$$MEF = \frac{\partial PNOF}{\partial TP}, TP > Opt$$

AEF (AVERAGE):

$$AEF = \frac{\Delta PNOF}{TP - Opt}, TP > Opt$$

Results: Heterotrophs in temperate lakes of Europe

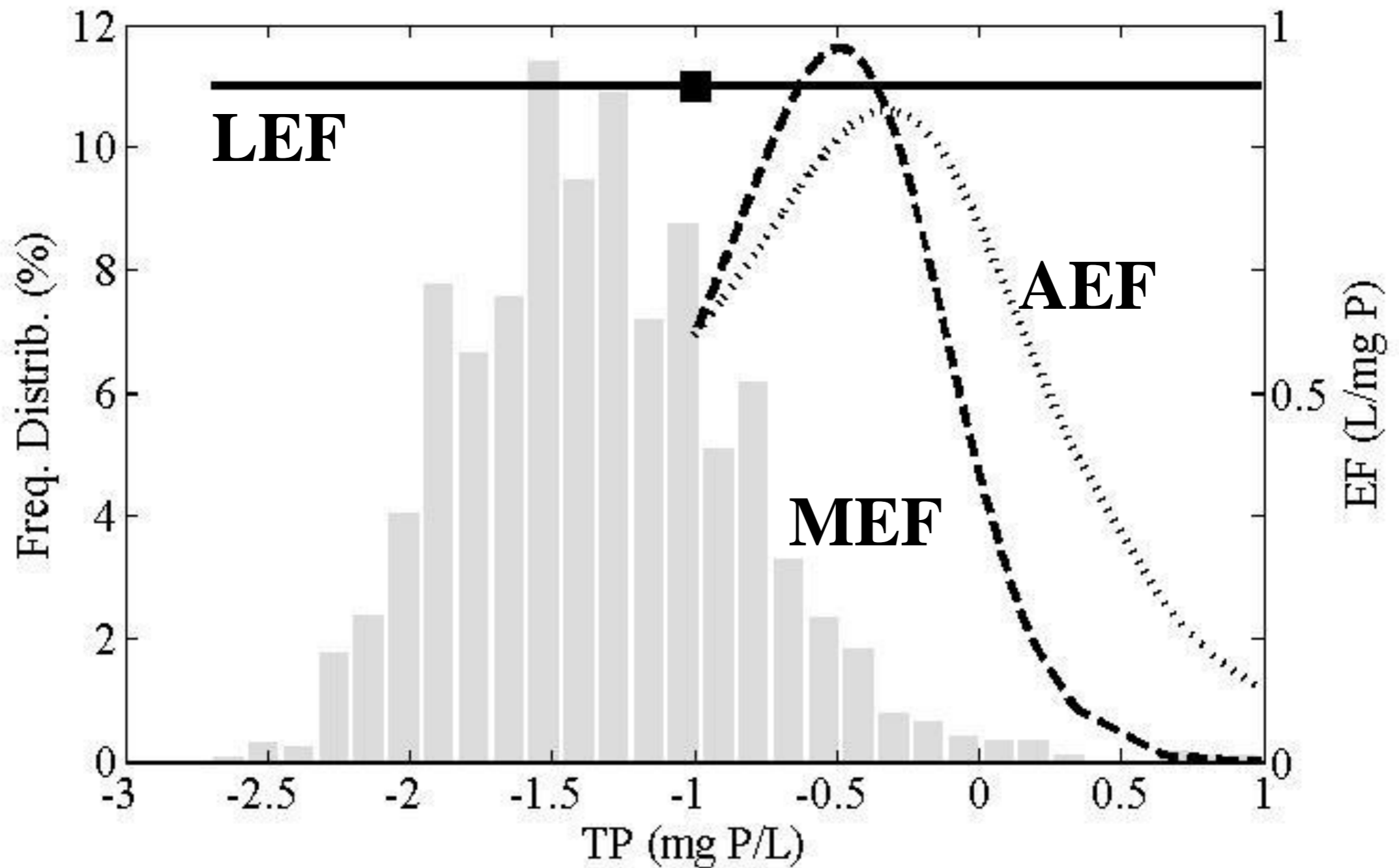

Applicability: Characterization model

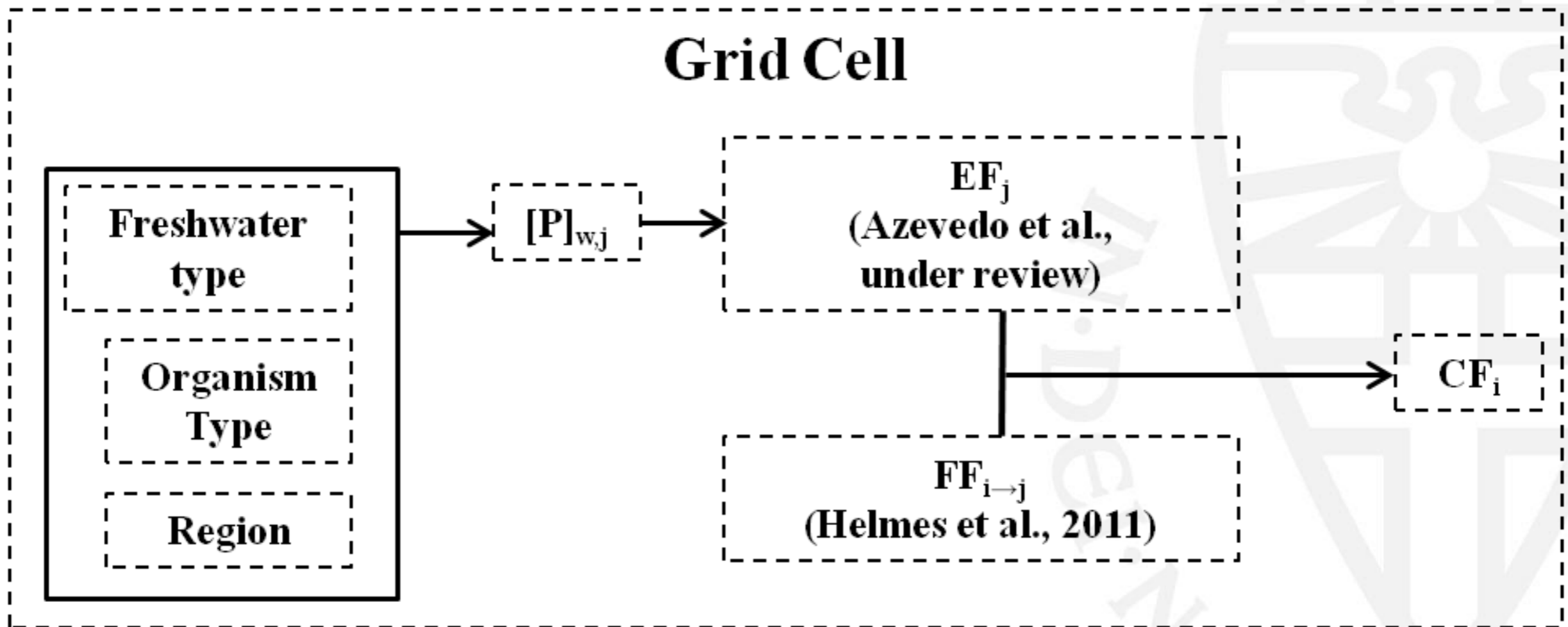

Results: Characterization factors

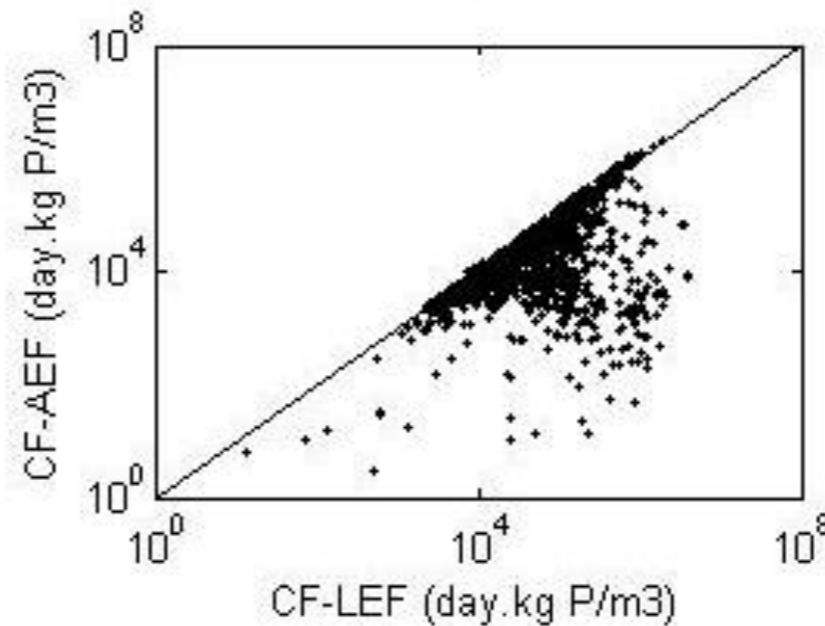
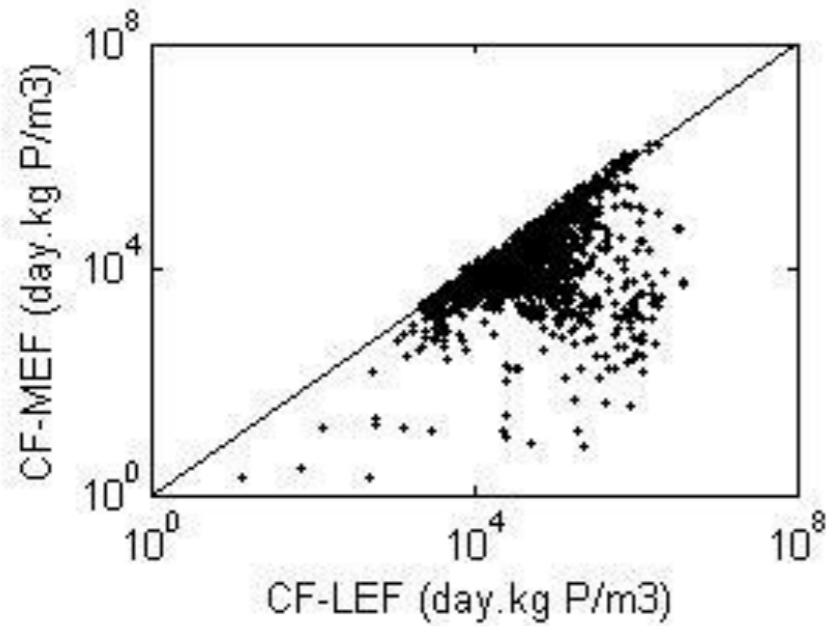

Difference between LEF and MEF/AEF: Up to 7 orders of magnitude

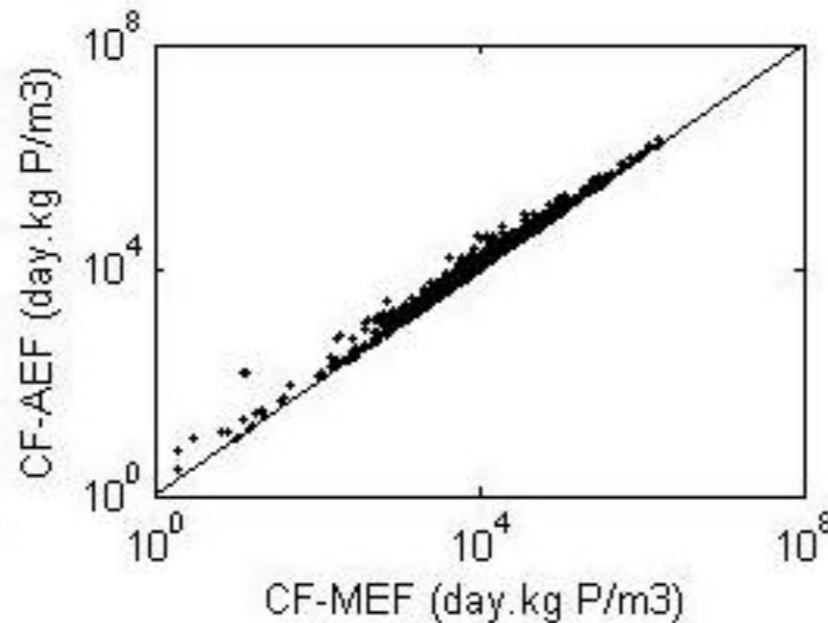

Difference between MEF and AEF: Up to 2 orders of magnitude

CONCLUSIONS

Endpoint characterization factors for freshwater eutrophication depend on the type of effect factor that is used

Depends on:

- 1) TP monitoring data:
Available (y/n?)/Level (high/low?)***
- 2) Specific TP target (y/n?)***
- 3) Let's not forget the fate factors!***

